

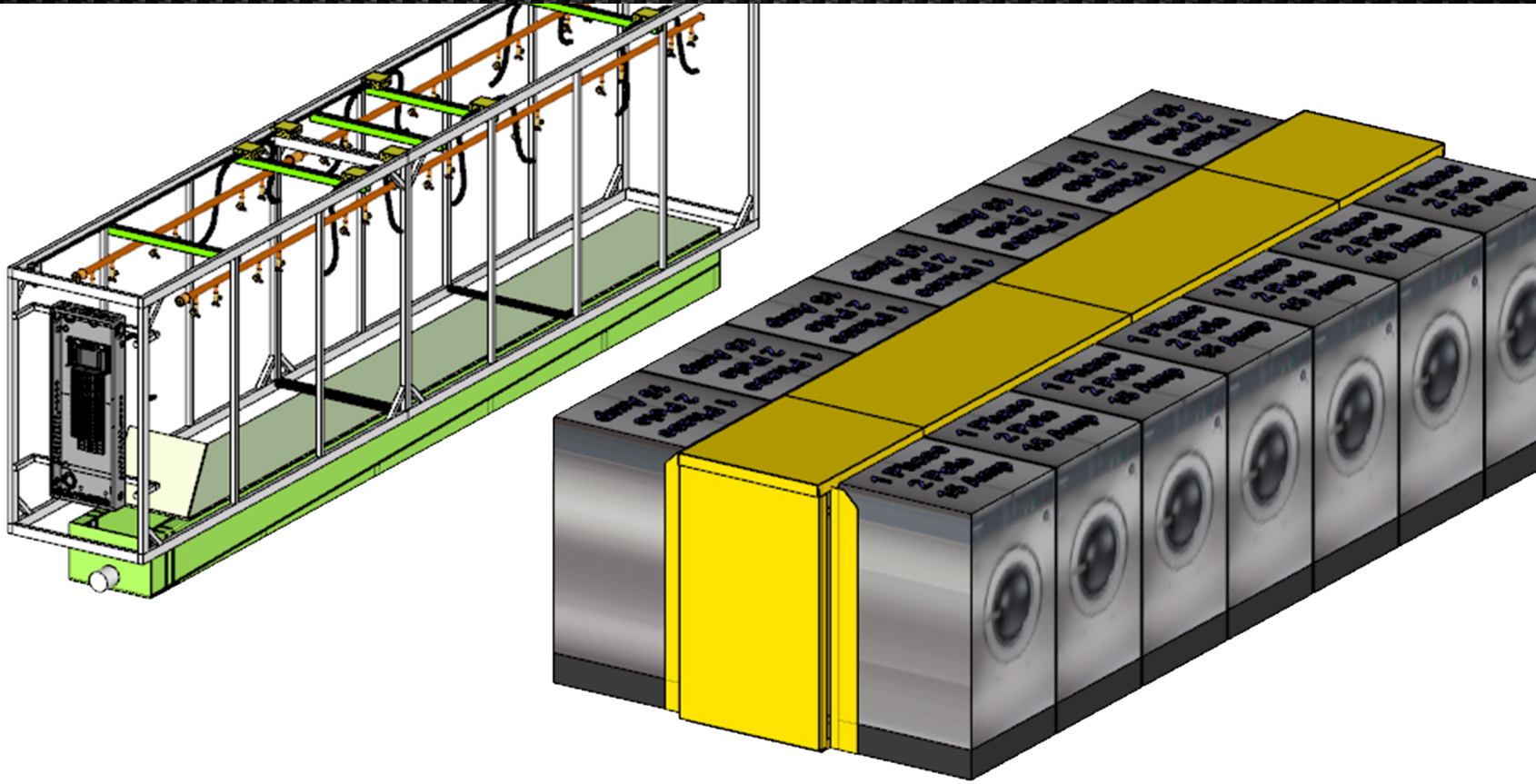

**CACO**  
MFG CORP



 **Bulkheads** 

 **Drain Troughs** 

 **Clouds**



# Bulkheads

by **CACO** MFG CORP **LISTED**

Engineering  
3-D CAD Drawing

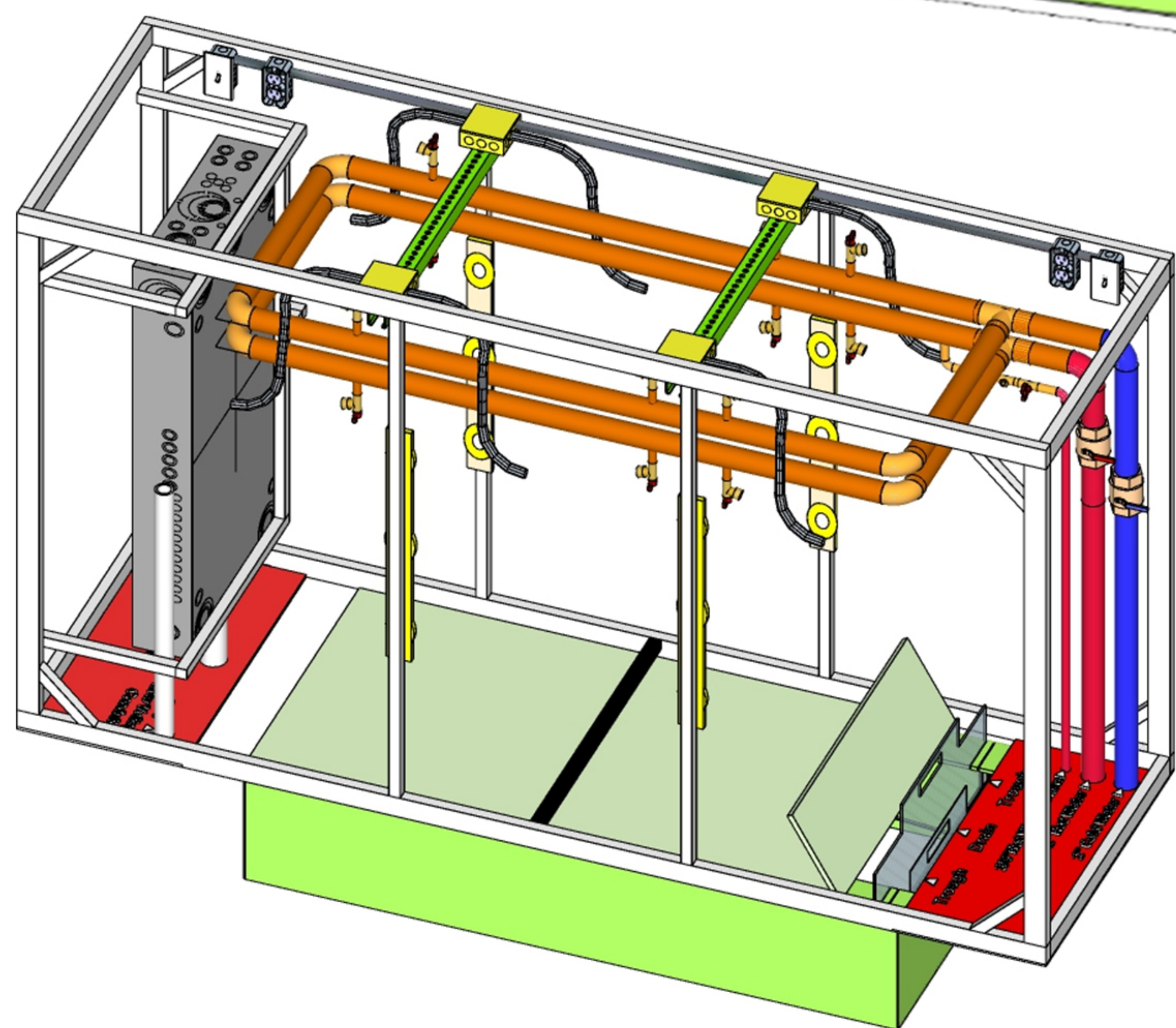
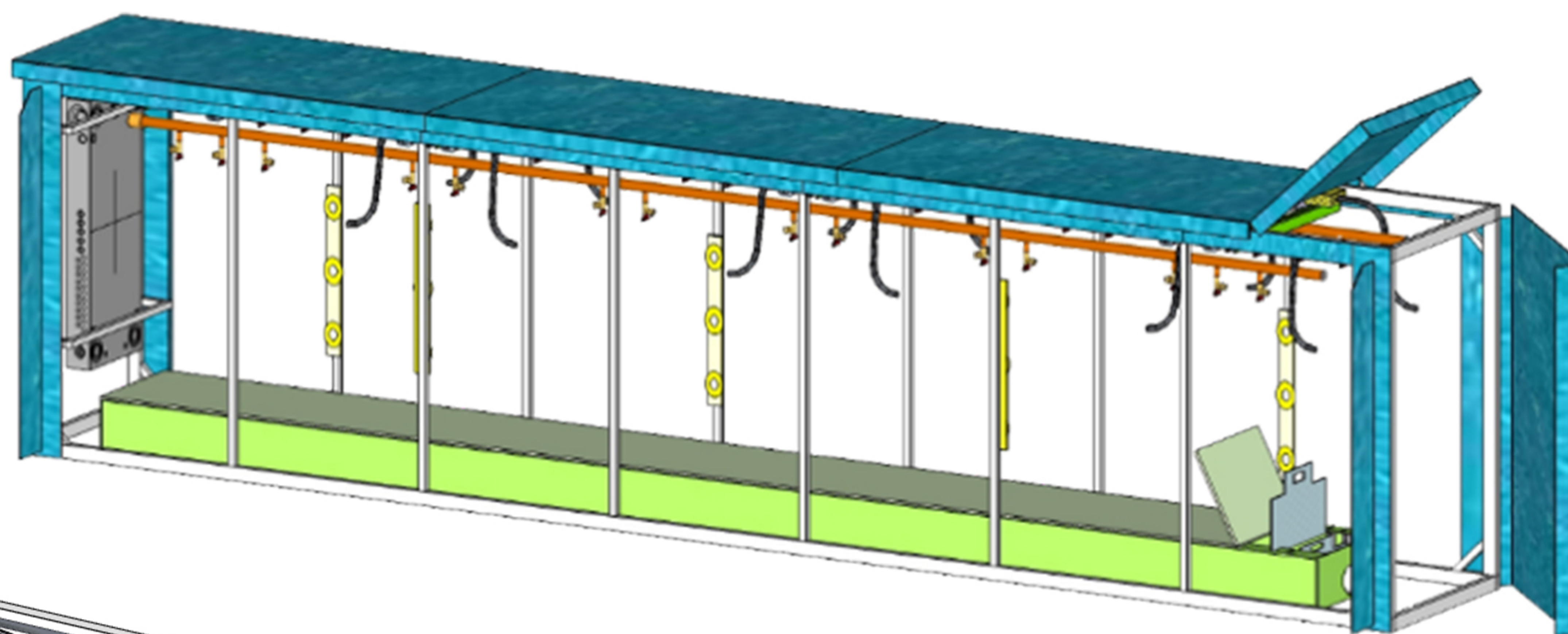
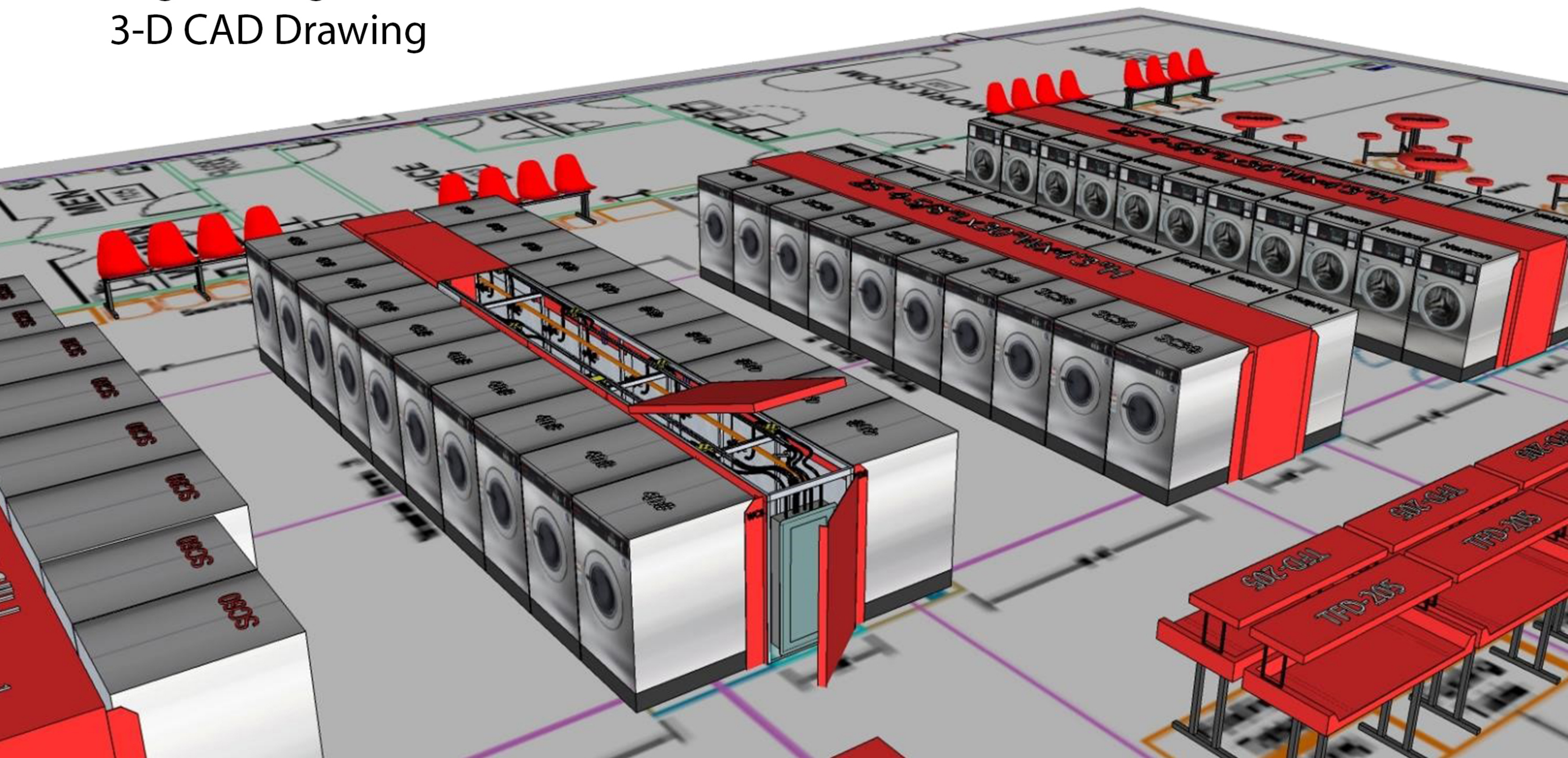

The galvanized metal frames fiberglass tops, side panels & doors, electrical system, drain system, and water lines are CAD designed for a perfect fit.



# Electrical & Plumbing



Square D® Panelboards  
Up to 72 Circuits



Internal LED Lighting

Rubber insulated pipe  
hangers prevent galvanic  
corrosion



Detailed wire labeling  
for easy final installation  
and identification.

1.5" or 2" Type L  
Copper Water Lines

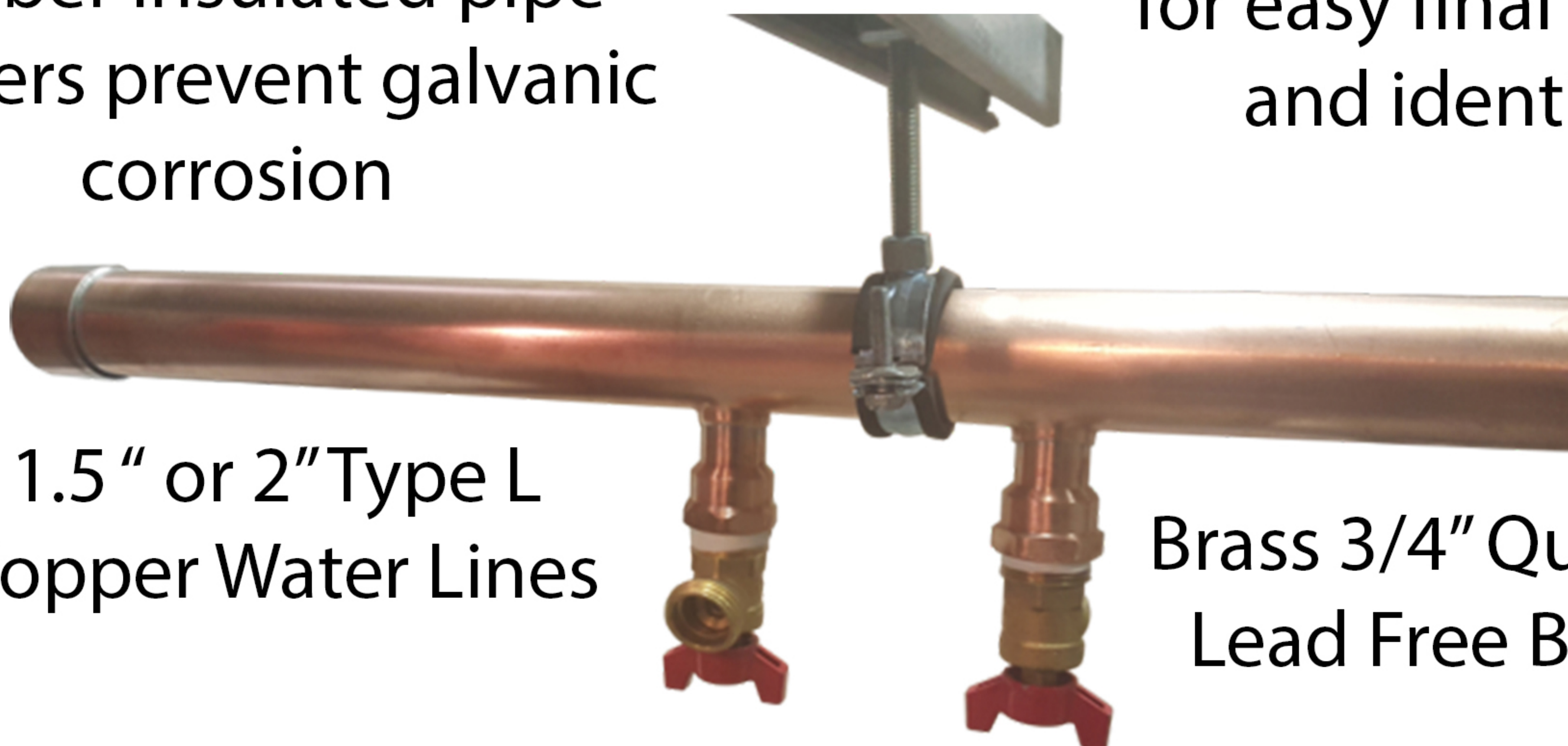

Brass 3/4" Quarter Turn  
Lead Free Ball Valves

# Frame & Covering

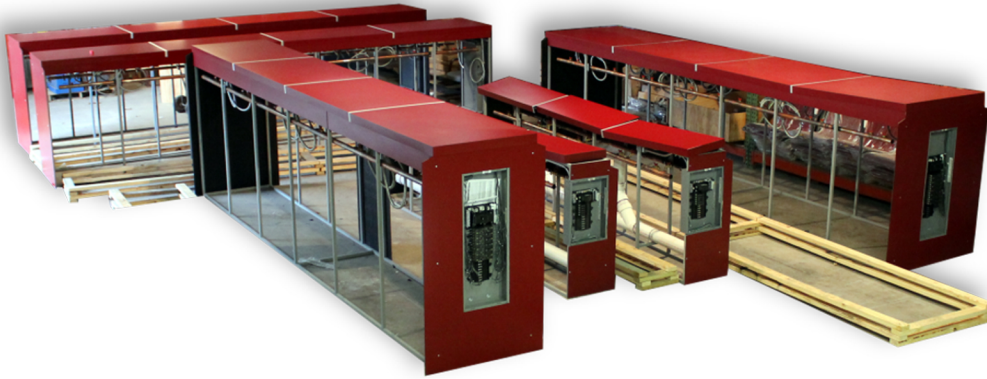

12-Gauge 1-5/8"  
UNISTRUT® supports



16-Gauge Galvanized  
Steel Tubing



Welded steel  
frames for  
superior  
strength  
and durability.



Custom fit fiberglass tops, side panels,  
and doors for dependable moisture  
protection inside and out.

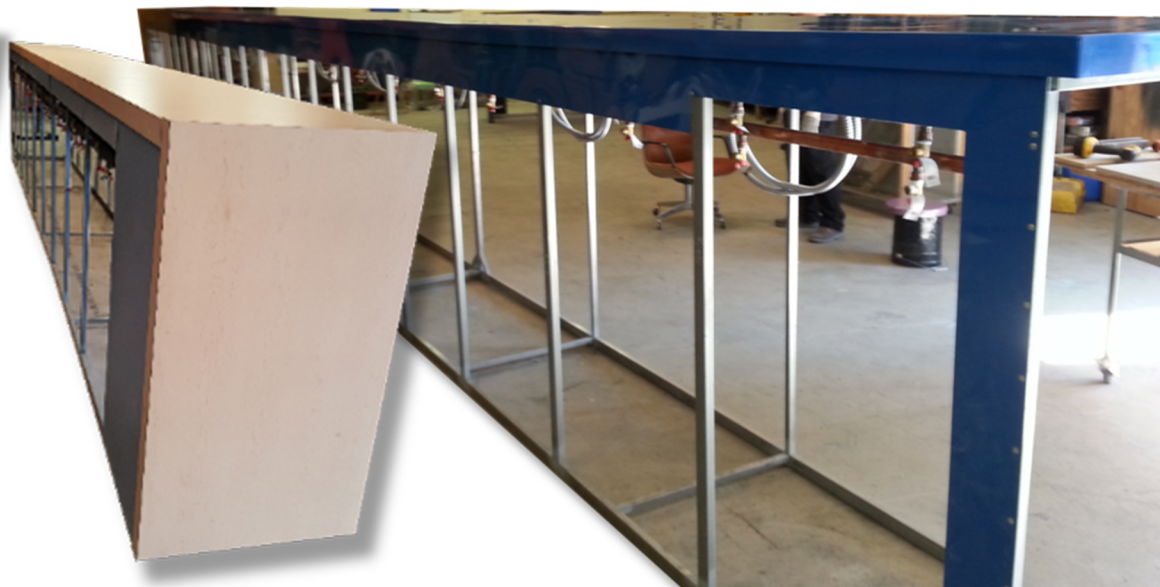

# Drain Troughs



by **CACO** MFG CORP

## Features & Benefits

- Troughs can be manufactured to any desired custom length.
- Dual Lint Filters to prevent drains from clogging.
- The Drain Outlet can be installed on the front, sides or bottom.
- Troughs come standard with a lid to reduce odors and prevent water splash out.
- The Lid is suitable for pedestrian traffic.
- Lid helps to contain excess suds.
- Troughs have a built-in slope towards the drain.
- Washing machine discharge drains can be installed in the top or sides.



## Patent Pending Drain Trough System

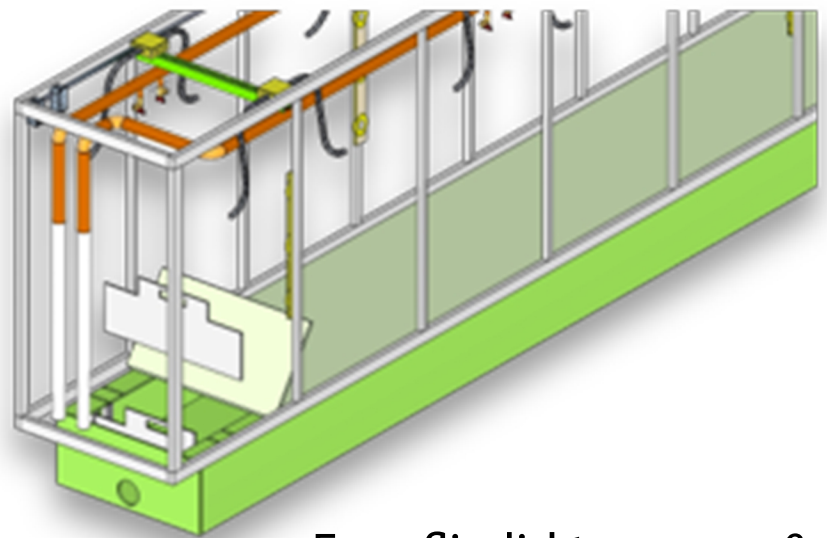

Easy flip lid to access & clean the dual lint filters

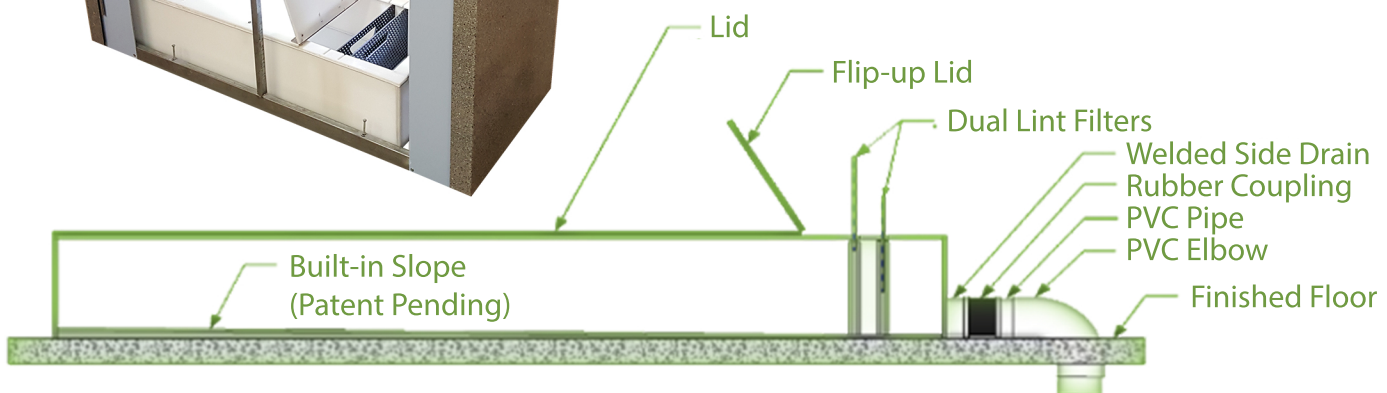
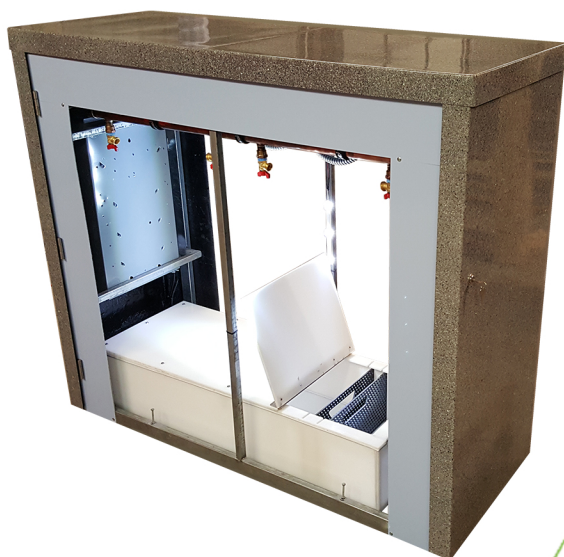



## Fiberglass Suspended Ceiling Fixtures

Available in your choice of color  
LED lighting option available

47" x 96" x 4"

Highlight & accent traffic zones

Sturdy UNISTRUT® mount

Functional & decorative

